

November 2018

SPI-M Modelling Summary

Prepared by the Scientific Pandemic Influenza Group on Modelling

Contents

Contents	1
Executive summary	2
1. Purpose.....	3
2. Background.....	4
3. Progression of a Pandemic.....	6
3.1 The initial outbreak.....	6
3.2 International spread	8
3.3 Geographical development of the pandemic, within the UK.....	10
3.4 What we know about the impact of an unmitigated pandemic	12
3.5 What we know about the impact of pharmaceutical countermeasures	15
3.6 What we know about the impact of social distance measures:	19
4. Potential subsequent waves	22
Annex 1: Indicative impacts of countermeasures.....	24
Annex 2: Advised National Planning Scenario for the Reasonable Worst Case.....	31
Annex 3: Additional advice on Local Planning Assumptions for Clinical Commissioning Group (CCG) sized areas	34
Annex 4: Data Required for Real Time Modelling in an Influenza Pandemic.....	35
Annex 5: Glossary	39
Annex 6: References	40

Executive summary

This document represents the consensus view of the Scientific Pandemic Influenza Group on Modelling. It is not a polished report of the group's deliberations and conclusions. Rather, it is a working document, updated as necessary after each meeting of the group, to record the group's advice in a form that can be immediately used to assist in policy formulation and is intended for a technical audience.

The document is focused on those results that directly influence policy. It not only contains statements of what might happen but also the group's view of the policy implications. This takes the form of notes on 'What we know' and 'Implications for planning'. However, other factors such as practicality, proportionality and questions of value for money are also important in the generation of an effective policy. These factors are outside the remit of the sub-group. When relevant, modelling of such factors is the responsibility of the Department of Health and Social Care's analytical teams and similar groups in other government departments.

The views of the group should not therefore, be taken as a definitive statement of current government policy but only of the group's advice based on their own scientific understanding. The UK Government's approach towards planning for influenza pandemics is given in the [UK Influenza Pandemic Preparedness Strategy 2011](#) (DHSC 2011).

Sometimes the document lists unresolved modelling questions. These represent either work in hand, or topics to which the group intends to return when higher priority work has been completed.

This document should be read as a whole and not treated as a series of independent statements.

1. Purpose

The purpose of this paper is to summarise the results of epidemiological modelling on Pandemic Influenza and their implications for policy. The view presented in this paper represents a consensus agreed by the Scientific Pandemic Influenza Group on Modelling. The paper is regularly updated.

The focus of this paper is on the modelling results for significant pandemics, of which there were three in the twentieth century: 1918-19, 1957-58, and 1968-69. Such significant pandemics result in a relatively large number of people becoming clinically ill, suffering complications, requiring hospitalisation, and dying. The more recent H1N1 2009 pandemic had considerably lower impact. The policy importance of the 2009 outbreak was as an exemplar of an event, which, at least in its early development, is difficult to distinguish from a much more significant epidemic.

The general aim is to describe the results as they impact on policy. The goal is to assist in the development of a set of flexible responses that cover (in an appropriate and feasible way) the whole range of risk (e.g. possible disease parameters). Robust solutions that cover a wide range of scenarios are preferred. However, where such solutions cannot be found, the decision points where a choice between different responses needs to be made, and the lead indicators required to inform that choice, should be identified. An important outcome of adopting this kind of approach will be an indication of which areas of the existing plans are sufficiently robust or flexible and which require further development. This development may involve further research / modelling, or it may involve additional policy decisions.

More particularly, the purpose of this paper is to summarise broadly, and at a relatively high level, our current knowledge as it impacts on determining an operational response. As a means of structuring the information, we have taken a chronological approach. We consider the possible progression of a future pandemic flu strain from its country of origin to, and then within, the UK. We identify key stages of this progression, and where appropriate we summarise the implications for planning.

2. Background

What we know about pandemics and epidemics:

- a) Much of our understanding comes from epidemics in livestock, especially the foot-and-mouth epidemics of 1969 and 2001 in the UK, and Ebola in west Africa in 2015-16 as well as the pandemics of MERS (Middle East Respiratory Syndrome), SARS (Severe Acute Respiratory Syndrome), and HIV-AIDS.
- b) Such emerging or re-emerging or re-introduced diseases pose significant threats to national and international “soft infrastructure”, including trade, tourism and productivity.
- c) Novel viruses and bacteria are continuously emerging, and the exact nature and timing of the next epidemic/pandemic is impossible to predict.
- d) Preparatory work between epidemics is necessary to enable governments and institutions to react appropriately when threats emerge. The UK Government’s approach to preparing for pandemic influenza is described in the UK Influenza Pandemic Preparedness Strategy 2011.

What we know about pandemic influenza:

- a) There were three significant pandemics in the twentieth century: 1918-19, 1957-58, and 1968-69-70, and one in 2009.
- b) In the UK there were three waves associated with 1918-19 pandemic. The wave structure of this pandemic is not well understood. The final 1919 wave may have been a separate pandemic of a different virus to the 1918 waves. The smallest of the waves was in July-August 1918, the largest second wave was from October 1918 to January 1919, and the third wave was from February to April 1919. Estimates of the national clinical attack rate (CAR) vary but suggest nationally it was around 25% of the population (totalled over all waves). The highest clinical attack rates were seen in the young. Estimates of the case fatality ratio (CFR) are around 2%, relatively evenly spread across the population, though with an excess in young adults.
- c) In the UK the 1957-58 pandemic came in one wave with most of the deaths occurring from September-February. Estimates of the national clinical attack rate vary, but suggest nationally it was around 30% of the population. Estimates of the case fatality ratio are around 0.1 to 0.2%. These average figures mask the considerable variation by age, most deaths being in the older adult population. However, most illness was in the young.

- d) The 1968-69 pandemic came in two waves in the UK, which was unusual in global terms. In England and Wales, the first wave peaked around February-March 1969 followed by a large peak in the 1969-1970 flu season. Estimates of the national clinical attack rate vary, but based on comparisons with the epidemic in the United States, it may have been around 35% of the population. Estimates of the case fatality ratio are around 0.2 to 0.4%. These average figures for mortality mask the considerable variation by age, with again most deaths being in the older adult population. In this case however, illness was spread evenly across age groups.
- e) The recent H1N1 2009 pandemic produced no significant signal of excess deaths in the overall population although approaching 700 people in the UK are known to have died from confirmed H1N1. Case ascertainment is unlikely to have been complete, and the true number is almost certainly higher. Royal College of General Practitioners (RCGP) rates of consultations were highest in the young. There were significant levels of background immunity amongst adults. The epidemic consisted of two 'waves', one immediately following the other. The first 'wave' peaked at the beginning of the school holidays in mid-Summer when contact rates in children reduced. Once schools returned in September, infections grew again until mid-October when there were not enough susceptible individuals left to sustain the pandemic. Estimates of the national clinical attack rate vary. Synthetic case figures used to track the epidemic suggest a clinical attack rate of 1 to 2%. However, modelling suggests that these estimates reflect only around 10% of those infected (Baguelin et al. 2010), which is consistent with serological analysis of the first wave (Miller et al. 2010). If, as is typical for influenza, only half of those infected were symptomatic though possibly with very mild symptoms, the clinical attack rate would be around 5 to 10%. If so, estimates of the case fatality ratio are around 0.01% (Presanis et al. 2011) In terms of age groups, mortality was spread evenly across the age groups although most illness was in the younger groups. An antigenically similar H1N1 virus was responsible for a significant epidemic of seasonal influenza in 2010/11.
- f) The contrast between these pandemics illustrates that epidemics / pandemics are heterogeneous, and that the next pandemic will be unique in many ways. In particular, it is important not to use the 2009 experience to predict the severity of the next pandemic.

3. Progression of a Pandemic

3.1 The initial outbreak

What we know:

- a) A pandemic virus could first emerge anywhere in the world. Two of the three pandemics of the twentieth century may have emerged in China (1957 and 1968), whereas the 2009 pandemic emerged from Central America. Most of the H5N1 and H7N9 avian influenza cases were originally identified in Asia, though H5N1 has since been detected elsewhere, for example in poultry and humans in Egypt. Any could evolve into a virus capable of spreading efficiently in humans. Although the focus of initial outbreak modelling has been on Asian outbreaks, the conclusions from such modelling results are informative wherever a future pandemic starts.
- b) The first steps in managing a global pandemic are summarised in the WHO Pandemic Influenza Risk Management Guidance – and focus on enhancing surveillance with collection of clinical, virological and epidemiological data to assess in particular the extent of human-to human transmission and support interventions to reduce the spread of influenza.
- c) The practicality of such measures depends on effective local planning to identify the first human cases, provide antiviral drugs and implement quarantine and other social distance measures. Such measures were not possible in the 2009 pandemic as there were 6,000 to 32,000 pandemic H1N1 infections in Mexico by late April 2009 when the strain was widely identified and reported (Fraser et al. 2009).
- d) Regardless of whether early containment measures prove to be effective, disease surveillance including case-contact studies will be required to estimate important disease parameters such as the (age-specific) clinical attack rates, the household secondary attack rate and infection-severity rates, as well as descriptions of clinical pattern. It is uncertain exactly how long it will take to derive reasonable initial estimates for these and other key parameters. If the disease is recognised early and takes 2 to 4 weeks to spread to the UK (see section 3.2), initial upper bound estimates of the mortality rate (and the general qualitative nature of the pandemic) may be available by the time it reaches the UK. More useful estimates may not be available until there have been significant cases in the UK. Clinical attack rates (and therefore case fatality ratios) are particularly difficult to estimate, so accurate estimates for these parameters may take longer to derive. It is important to ensure mechanisms are in place to measure rates of infection in the community at different stages of the pandemic to enable this to be possible (see Appendix 4: Data required).

- e) It will be critical to ensure systems are in place to estimate pandemic severity and compare to measures seen for seasonal influenza. As part of this the UK is participating in the WHO led Pandemic Influenza Severity Assessment network (WHO PISA). Initial severity estimates will be problematic for numerous reasons. Not all early cases will be confirmed in a laboratory, and those with milder symptoms may never contact health services. This highlights the importance of thorough contact tracing with serology to ensure the whole spectrum of illness is detected. The delay in the reporting of hospitalisation and death from the onset of symptoms will affect any estimates of case hospitalisation and fatality ratio. Outbreaks that have completed can be difficult to locate. Background immunity is likely to be unknown initially and it will be important to ensure valid serological tests are developed and deployed and systems are in place to measure the population immunity and the rates of infection. Laboratory tests may still be in development and not widely available. Different health systems may show different propensities to consult healthcare, leading to different 'denominator' information.

Implications for planning:

- I. Encourage arrangements that facilitate the early collection and sharing of data (similar to that described in Annex 4) between nations including the collection of case-contact information and sero-epidemiological data. Continue to actively participate in international initiatives such as WHO PISA.
- II. Ensure that all intervention strategies are able to accommodate the full range of possible disease parameters, including the possibility of outbreaks without significant impacts in terms of hospitalisations and mortality. Put in place mechanisms to easily modify the response as further information becomes available.
- III. Assist international efforts to make sufficient courses of antivirals available for use in initial containment.
- IV. Encourage construction of realistic and detailed local plans for containment in the source country. (This is different to attempting to contain the virus once it is widespread which has little chance of success, see section 3.3).

3.2 International spread

What we know:

- a) The UK generally has a high volume of international travel, and so is likely to be one of the earlier countries to receive infectious individuals. For example, the UK was one of the first countries in Europe to have confirmed H1N1 cases in 2009, the first confirmed cases occurring within a week of the recognition of a public health emergency of international concern.
- b) Simulations of outbreaks beginning in rural parts of Asia suggest that having taken 2 to 4 weeks to build up in the country of origin, pandemic flu could take as little as 2 to 4 weeks to spread from Asia to the UK, with the peak of the UK epidemic following about 50 days later (Cooper et al. 2006, Ferguson et al. 2006 and broadly in agreement with Colizza et al. 2007). However, in a mild pandemic such as 2009 it might take some time for even significant levels of infection to be recognised as an international health emergency, and the time from recognition to arrival in the UK might be much shorter. Indeed, some (unconfirmed) cases may already be present in the UK before such recognition.
- c) Low-level restrictions in international travel (e.g. less than 70% of journeys) would have a minimal impact (Mateus et al. 2014). Even relatively high levels of travel restrictions would only delay an epidemic for a few weeks. For instance, imposing a 90% restriction on all air travel to the UK would delay the peak of a pandemic wave by only 1 to 4 weeks (Cooper et al. 2006, Mateus et al. 2014). A 99.9% travel restriction might delay a pandemic wave by 2 months (Cooper et al. 2006, Ferguson et al. 2006).
- d) Travel restrictions **into** the UK from country of origin (if it is known) will be compromised by travel into the UK from intermediate countries that develop their own epidemics. Regional travel restrictions into the UK will be increasingly disruptive for relatively little benefit.
- e) Putting restrictions on all air travel **from** the country in which the pandemic strain originates (i.e. a self-imposed or internationally imposed measure) is likely to produce delays similar to those expected for restrictions on all travel into the UK.
- f) If restrictions on travel from all countries which had epidemics of pandemic flu were put in place internationally, the effect could be somewhat greater: a 90% reduction might delay the spread by 3 to 4 weeks and a 99.9% effective ban by 3 to 4 months (Cooper et al. 2006). If the UK has cases early in the pandemic, then this would involve travel restrictions **out** of the UK.
- g) Estimates on the delays caused by different travel restrictions depend on various

assumptions, including the transmissibility and generation time of the influenza virus. For lower transmissibility, although there may be some quantitative changes to the estimates above (Mateus et al. 2014), these would not, in general, be large enough to make a difference for policy decisions.

- h) While clearly possible in principle, for all practical levels of restriction, there is little chance of a country missing the pandemic altogether due to travel restrictions (Cooper et al. 2006).
- i) Screening is less effective than restricting travel generally. Preventing those with clinical symptoms from travelling is only likely to delay the spread of the disease by 1 to 2 weeks. Assuming passengers are screened before travel for clinical symptoms, there is very little additional advantage in entry screening (Pitman et al. 2005). Screening on entry to the UK poses considerable policy questions (e.g. whether potential cases are quarantined) and planning (i.e. it requires considerable resources) and is not recommended.

Implications for planning:

- I. Assume no significant epidemiological / disease control benefit from international travel restrictions.
- II. Assume that screening, either on exit from countries/regions, or on entry to the UK, will not have any significant benefit for considerable cost and disruption.

3.3 Geographical development of the pandemic, within the UK

What we know:

- a) It has been estimated that a pandemic flu outbreak would be expected to have been seeded (through international and internal travel) in most major UK centres of population within 1 to 2 weeks of the earliest importations (Ferguson et al. 2006). Modelling studies since 2006 using broadly similar modelling approaches have reached essentially equivalent conclusions for the UK (Merler S & Ajelli M 2010, Merler et al. 2011) and some other European countries (Ciofi degli Atti et al. 2008). It would then take some further time to show significant activity across the country, as was seen in 2009 (HPA 2010).
- b) Larger population centres are likely to be seeded with more cases early on during the pandemic. For example, 57% of international travellers visit London and 75% of visitors going to London, Manchester, Birmingham, Liverpool, Bristol, Glasgow and Edinburgh (ONS 2016). Significant seeding is expected from UK residents returning from abroad. Hence, at the early stages of the pandemic, case numbers may be larger in urban areas. Such differences in case numbers will primarily reflect the timing of the start of the local outbreak, as opposed to a larger overall clinical attack rate. As the epidemic in the UK develops the importance of seeding reduces quickly.
- c) Because of the probable multiple importations of pandemic flu, and the concentration of the population in cities, attempts at containment (similar to those explained in section 3.1b above) by antiviral prophylaxis and practical social distance measures are almost certain to fail (Ferguson et al. 2006, Nguyen-Van-Tam et al. 2004).
- d) Even very substantial reductions in internal travel between localities (of say ~90%) would have little effect on the length and peak size of the epidemic in each local area. However, coupled with the elimination of international travel, they could spread out a national epidemic by desynchronising the epidemics in the local areas (Mateus et al. 2014, and refs therein). Such restrictions are probably impractical. More realistic reductions in such travel would have a negligible effect on the national epidemic (HPA 2005).
- e) Transmission and development of the outbreak may be effected by changes in contact patterns, caused, for example, by school or seasonal holidays (e.g. Birrell et al. 2011, Dorigatti et al. 2013, Marziano et al. 2017).

Implications for planning:

- I. Assume, for the purposes of developing intervention strategies, that clinical cases will appear throughout the UK within about 2 weeks following the earliest detected cases arising from initial importations.
- II. Assume no benefit of internal travel restrictions, but expect change in mobility behaviour, which could affect local transmission.

3.4 What we know about the impact of an unmitigated pandemic

- a) A pandemic profile (i.e. the proportion of infections, clinical cases, hospitalisations and deaths expected each week) has been constructed to guide national planning (see Annex 3). The profile is similar to that of the second wave of the 1918 to 1919 pandemic in London. This profile represents the build-up that might be expected for a national epidemic. About 22% of new cases occur in each of the peak weeks.
- b) Local epidemics in Clinical Commissioning Group sized areas would be expected to be more highly peaked than the national epidemic, with a peak number of cases up to 50% higher. Similarly, they would be expected to be of shorter duration, perhaps by a third, than the national epidemic. Empirical evidence from 1918 suggests, however, that there may also be a large variation in epidemic profile from CCG to CCG. In 1918, two thirds of modern Clinical Commissioning Group sized areas had less peaked rates of mortality than suggested by the national planning profile, and a third more highly peaked mortality.
- c) The UK case fatality ratio (CFR) for four pandemics in the last 100 years was of the order of 0.01 to 2% (Nguyen-Van-Tam and Hampson 2003, see also section 2 above). In contrast, recent estimates of the case fatality ratio for H5N1 avian flu are of the order of 50% to 60% (see WHO website: Influenza).
- d) There has been a general (but not uniform) decline in influenza (pandemic and seasonal) and pneumonia mortality since the 1918 pandemic. However, the extent to which this decline can be attributed to the improved underlying health of the public, better healthcare or to changes in pathogen severity is unclear.
- e) Based on historical pandemics a 'reasonable worst case' for a pandemic would be a CFR of 2.5%. However, even if the estimates for H5N1 avian flu are overestimates for a naturally occurring viral strain adapted for efficient human to human transmission, an H5N1 pandemic would be expected to be towards the higher end of the range of historically observed case fatality ratio.
- f) A pandemic with a case fatality ratio above 2.5% cannot be ruled out.
- g) Mortality rates often vary by age. Age-specific mortality curves for 1957-58 and 1968-69 show a U-shaped pattern with a slightly increased case fatality ratio in the very young and then increasing case fatality ratio with increasing age. The 1918 pandemic on the other hand had a more equally spread mortality rate with particularly high mortality rates seen in young adults (Monto 1987).
- h) For the well documented pandemics over the last 100 years, the overall clinical attack rate (cumulative across all waves) has been of the order of 5 to 35% in the UK. Interpreting public health records from pre-20th century outbreaks is problematic but suggests a higher rate for the pandemic of 1889, in the range of

35 to 50% in the UK (Valleron et al. 2010, Finnie et al. 2011, Parsons 1891, 1893). As seen in 2009, there can be low impact pandemics with low clinical attack rates. A reasonable upper bound for the cumulative clinical attack rate for planning purposes would be around 50%. The reasonable worst case scenario with peak impact at any given time is hence a single wave pandemic with a clinical attack rate of 50%. The proportion of the population infected would be higher: estimates of the proportion of infected individuals who go on to become clinical cases generally range from one third to two thirds. (Mann et al. 1981, Longini et al. 2004, Monto 1987, Nguyen-Van-Tam and Hampson 2003, Carrat et al. 2008).

- i) Clinical attack rates may vary by age both due to different mixing patterns between age groups as well as partial immunity that can be distributed unevenly between age groups. Illness generally peaks in school children and/or young adults.
- j) In the early stages of a pandemic, the groups for whom the risk of complications or death is greatest will not be well known. However, groups identified as being at a higher risk of complications or death from seasonal influenza are likely to be at a higher risk of complications or death from the pandemic strain. As the outbreak progresses, surveillance data will accumulate, and it may become possible to better identify risk groups and estimate key disease parameters. If the pandemic starts abroad, reasonable estimates of some (but probably not all) disease parameters may be available by the time the disease reaches the UK. However, if the pandemic starts in the UK, no such estimates will be available initially.
- k) The provision of good background serology data will be key to providing estimates of initial immunity, which will be important for estimating the clinical attack rate.
- l) Contact tracing (including serological and virological testing of contacts) of the first few hundreds of cases in the UK, community surveys and individual outbreak analysis will be essential for the accurate determination of disease parameters, most importantly generation time and the proportion of cases showing clinical symptoms.
- m) Given a cumulative 50% attack rate over a single wave as in the 'reasonable worst case' discussed above, absence directly due to illness would be expected to peak at 17% for two to three weeks at the height of the epidemic (DHSC 2006b). Employers should also be advised to take account of the possibility of local geographical, behavioural and temporal variation. Small organisational units (5 to 15 staff) should plan to a higher level of absence of 30 to 35% (DHSC 2006b).
- n) For a typical organisation, additional absence (again in the reasonable worst case) due to those who need to stay at home to look after ill children might

increase absenteeism from 17 to 20% (DHSC 2006b).

- o) Both the positive (reduced transmission) and negative (reduced productivity) effects of absenteeism may be amenable to modification by suitable behavioural interventions. Setting priorities for the objectives of such interventions is hence essential to avoid 'mixed messages'.

3.5 What we know about the impact of pharmaceutical countermeasures

- a) Antibiotics are used to treat bacterial infections that might be exacerbated or initiated by an influenza (viral) infection. Antibiotics reduce the morbidity and mortality subsequent to influenza infection, but they do not impact on transmission.
- b) Antivirals can reduce the duration and severity of influenza symptoms. A policy of rapid treatment of those ill is the most efficient use of antivirals for stockpiles corresponding to treatment courses for less than 50% of the population (Ferguson et al. 2006). If the available stock is less than the clinical attack rate of influenza like illness (taking account of losses due to wastage), it will be necessary to limit treatment to priority groups (Gani et al. 2005).
- c) The mass treatment of clinical cases with antivirals could flatten the temporal profile, lowering the peak and lengthening the base if there is a high take up of treatment (Ferguson et al. 2006, Vynnycky 2005, Gani et al. 2005). In 2009 few of those infected were treated in the period of mass treatment (e.g. via the National Pandemic Flu service) because few of those infected consulted the healthcare system. Hence the overall impact of antivirals on transmission and in turn the clinical attack rate was negligible in 2009.
- d) Although the main purpose of antiviral treatment is to reduce the severity of the disease, treating all clinical cases with antivirals might also decrease the overall attack rate (Ferguson et al. 2006, Gani et al. 2005). There is considerable uncertainty over the extent of the reduction possible. Some models suggest a relative reduction of up to one third. This suggests, for example, that treating all cases in an outbreak for which the attack rate would be 50% without treatment would require enough antiviral courses for ~35% of the population.
- e) To obtain the most effect the drug must be administered within 24 hours of the start of symptoms. Delivery within 48 hours (advised by NERVTAG as a plausible practical assumption) is less effective but still beneficial and cost-effective. Venkatesan et al. 2017 reported "earlier treatment (within 48 hours of symptom onset) was significantly more beneficial than later treatment". In addition, to obtain a substantial effect on transmission, a sizable proportion of those infected must take the drug. In 2009 there was little impact on transmission because few of those infected showed ILI and only a proportion of those sought care. Of those patients with ILI who used the National Pandemic Flu Service (NPFS) 65% collected antiviral treatment. Whilst some have questioned the effectiveness of antiviral treatment, Public Health England recommends its use and a recent European Centre for Disease Prevention and Control (ECDC) review (ECDC 2017) said "Although the available evidence on the current neuraminidase inhibitors is limited in scope (with regard to risk groups and severe outcomes), and the estimates of effectiveness are modest, the expert consensus was that it

is sufficient to justify use of these medicines for providing protection against the development of influenza disease, the duration of symptoms if disease develops, and probably also the progression to severe outcomes”.

- f) Mass provision of antivirals to the population would simply postpone the outbreak by the period for which prophylaxis is provided (Vynnycky et al. 2005, Longini et al 2004). However, such mass prophylaxis would deplete antiviral stocks very quickly (at a rate of one treatment course per 10 person-days).
- g) Another possible practical use for antivirals is prophylaxis of essential workers leading to a possible two thirds reduction in both peak and total clinical attack rates for the groups receiving prophylaxis (Ferguson et al. 2007). The cost, in terms of antiviral stocks, of such prophylaxis is a function of the number of workers who are classified as essential, the duration over which they are offered prophylaxis, and whether prophylaxis is additionally provided for their close contacts. The costs in terms of antiviral treatment courses would be large, for example around half the current Tamiflu stock for front line NHS workers alone. A further problem is that, unlike those treated, those who receive prophylaxis for the duration of the first wave and do not develop clinical or sub-clinical infection would not be immune at the start of a second wave.
- h) Stockpile levels over 50% are sufficient to allow post-exposure prophylactic options to be considered. Post-exposure antiviral prophylaxis of the household contacts of cases could have a more marked impact on the disease than simply treatment of cases (Ferguson et al. 2006), and in the 2009 pandemic a combination of treatment of index cases and household prophylaxis reduced the clinical attack rate in households from 10.6% to 4.5% ($p < 0.003$) when given within 48 hours of illness onset in the index case (Pebody et al. 2011). Such ‘household prophylaxis’ would be more effective in mitigating and delaying the progress of the epidemic than antiviral treatment alone (Ferguson et al. 2006).
- i) Given any stockpile sufficiently large for household prophylaxis to be a possible option, starting with prophylaxis and, if necessary, reverting to treatment (and if necessary targeted treatment of at risk groups/children) is likely to result in the smallest number of deaths. On the other hand, the greatest reduction in peak attack rate is more likely to be obtained by continuing the household prophylaxis strategy to stockpile exhaustion.
- j) At onset of a pandemic influenza epidemic in the UK, there will not be a good vaccine that matches the characteristics of the new virus. Prior vaccination with a poorly matched pre-pandemic vaccine and antibiotic treatment of those with complications would help control the overall impact on hospitalisations and deaths (Ferguson et al. 2006, Vynnycky et al. 2006). Scenarios given here have the conservative assumption that a pre-pandemic vaccine has only 20% efficacy. Indicative numbers of cases, hospitalisations and deaths for different scenarios are shown in Appendix 1.

- k) Stockpiling enough pre-pandemic vaccine for 40% of the UK population would allow a 'targeted' strategy of vaccination of all those aged 16 or under and all those aged 65 or over. Vaccinating school-age children may be highly effective in reducing transmission, but only if vaccine is available early enough in the pandemic, since rapid transmission in this group means that many will already have been infected and acquired natural immunity before a pandemic vaccine is likely to be available (Baguelin et al. 2010, 2013).
- l) For a 1918 like pandemic, a policy of timely household antiviral prophylaxis, limited school closures (see below), and antibiotic treatment of complications could be expected to essentially halve the clinical attack rate and reduce the number hospitalisations and deaths by 80-90% compared with no intervention. Even for a more extensive pandemic, such a combined intervention might lead to reductions in the number of cases in excess of 40% and in deaths and hospitalisations by more than 80% (DHSC 2006a).
- m) Pre-pandemic vaccination of 100% (rather than 40%) of the population (again with the use of antiviral household prophylaxis and antibiotic drugs for complications) would lead to a substantially greater 80%-90% reduction in the number of cases and around a 95% overall reduction in deaths and hospitalisations. (DHSC 2006a).
- n) For a 1918 type of epidemic the combination of interventions, including pre-pandemic vaccine might suppress the national epidemic entirely leading to only local outbreaks of seasonal influenza proportions. For a more extensive pandemic, such a combined strategy might still reduce the number of cases by around 60%, and deaths and hospitalisations by 80-90%.
- o) Such combined interventions would still have significant impacts even if one intervention was less effective than expected. In addition, stockpiling enough antivirals to treat more than 75% of the population increases the likelihood of still exerting reasonable control over the scale and severity of the national outbreak even if antiviral prophylaxis or vaccination proves to be less than fully effective (DHSC 2006a) and/or there are significant antiviral losses in treating non-pandemic influenza like illness and wastage.
- p) The estimated impact of antiviral treatment and household prophylaxis discussed above and in annex 1 assumes treatment within 24 hours of the first symptoms and that those with clinical symptoms are treated at home (Ferguson et al. 2006). Greater delay or the greater mixing of those with clinical symptoms will reduce the impact of any antiviral policy. In 2009-10 only a minority of patients obtained care within 24 hours of illness onset: only 42% of patients examined by a GP were seen within 48 hours, compared with 66% of NPFS patients. Delays in getting treatment via NPFS were generally due to delays in patients seeking care. Encouraging faster care-seeking would increase the effectiveness of treatment.

- q) The above estimates of impact also assume that the uptake of pharmaceutical measures is prompt and universal. In the UK, in 2009, uptake of antivirals was low, mostly due to low rates of care-seeking (Brooks-Pollock et al. 2011), and low rates of prescribing by GPs (in contrast, 65% of NPFS patients with influenza-like-illness obtained treatment). Vaccination only reached ~40% in the identified at risk groups by the end of the epidemic.
- r) As the effectiveness of pharmaceutical countermeasures is well established and there are diminishing returns from information campaigns, establishing a high take-up of antivirals and vaccine should be a priority target of efforts at guiding behaviour.

Implications for planning:

- I. Develop a flexible system that would enable antiviral prophylaxis, antiviral treatment for all, or antiviral treatment to be targeted dynamically at different priority groups as required. Begin with household prophylaxis but revert to more restricted use if indicated by stockpile usage and surveillance information.
- II. Ensure that there are robust data collection systems in place that will be able to capture information regarding attack rate, disease pattern, severity, mortality, the propensity to seek healthcare and the background level of immunity in a timely and reliable way. This should include contact tracing (including virological/serological investigation of contacts) of the first few hundreds of cases.
- III. Plan to the planning assumptions in Annex 2, and Annex 3, recognising that these will need revision on the basis of surveillance information from both the UK and abroad.

3.6 What we know about the impact of social distance measures:

- a) In addition to the medical countermeasures of vaccination, antivirals and antibiotics, various social distance measures might be used to reduce interpersonal contacts, reduce transmission and hence the progress and extent of the epidemic. Two such measures are restrictions on mass gatherings, and school closures of various kinds - individual classes, local, regional, national, pre-emptive, scheduled or reactive (Cauchemez et al. 2009).
- b) The impact of any intervention including closing schools depends critically on the mixing between children and adults, as well as the age dependence of any background immunity.
- c) Assuming little or no background immunity, different plausible models (Ferguson et al. 2006, Cauchemez et al. 2008) give results suggesting a reduction in peak of up to 50%, depending on when in relation to the epidemic progression and for how long schools are closed. The corresponding reduction in the total number of cases is in the range of 10 to 20%. Much of the reduction in the total number of cases would be in school age children.
- d) On the other hand, if there were significant background immunity amongst adults there may be a more considerable impact on the pandemic. For example, in the UK in the 2009 pandemic, school holidays (possibly in combination with general summer holidays) suppressed the epidemic over August (Eames et al. 2012). However, to be used successfully as a suppression strategy, closures would need to be maintained until pandemic specific vaccines were available.
- e) School closure is therefore most usefully employed if children are particularly badly affected, or if there is known to be significant background immunity in adults.
- f) The impact of any school closure policy would depend on the timing and length of the school closures in the specific circumstances of the epidemic. However, in the case of mitigating (rather than suppressing) an epidemic, closing schools reactively (after a case of flu in the school) for three weeks produces almost the same effect as longer or more widespread closures (Ferguson et al. 2006). However, a school may have to close a number of times under such a policy and longer or more widespread closures may be more practical.
- g) Combined with a household prophylaxis policy rather than simply treating cases, closing schools would have a more significant effect on the profile of the epidemic and the overall number of clinical cases (in adults as well as children), (Ferguson et al. 2006) as shown in Annex 1.

- h) As noted above, absence directly due to illness could peak at up to 17% for two to three weeks at the height of the epidemic (DHSC 2006b, SQW Consulting 2007). Under the same reasonable worst case assumptions, for a typical organisation, additional absence due to those who need to stay at home to look after ill children might further increase absence from 17 to 20% (DHSC 2006b). However, if schools were closed, absence due to those staying at home to look after children could rise to 15 to 20% throughout the period of school closure, independently to the extent and severity of the epidemic (DHSC 2006b, Sadique et al. 2008). In an epidemic approaching the reasonable worst case, a total absence level including illness and those caring for children might approach 30 to 35% at the peak, though evidence from school holidays and teachers' strikes suggests this may be an overestimate (DHSC 2006b, SQW Consulting 2007).
- i) If schools are closed it will be important to discourage the gathering of children into school-like childcare settings e.g. mass childcare provision by employers (Inglesby et al. 2006) as this would negate any health benefit of the policy.
- j) Little direct evidence is available on the effects of cancelling large public events. However, the results might be expected to be similar to those for closing schools, albeit on a considerably more limited scale. Some benefit might be expected for those who would have otherwise attended the events but very little for the overall community. Some benefit might also be expected from the reduction in travel to such events. However, the benefits of even major reductions in all travel are small. These conclusions are consistent with the lack of important observable differences between the course of seasonal flu outbreaks in London, where there is considerable mixing on commuter trains and underground railways, and the course in other parts of the UK.
- k) Voluntary home isolation, i.e. people staying at home if they show 'flu like' symptoms, will decrease the number of contacts between infected and uninfected individuals, and hence is likely to decrease the spread of infection.
- l) The combined effects of various social distancing measures (including closing schools, cancelling large public events, closing places of entertainment, and home isolation) if started very early on in a locality affected by influenza may have a significant impact on reducing transmission. In some US cities in the 1918 to 19 pandemic it is thought that the combined measures reduced R to less than 1 (from an R_0 value of 1.4 to 2) however such measures would need to be maintained until sufficient quantities of pandemic specific vaccine became available. In the US cities, when the measures were relaxed there was a second wave of infection.
- m) All social distance measures depend on compliance by the population which, in turn, depends on the social acceptability of the measures. Without good behavioural research on these it is difficult to predict the impact of such measures being deployed in a future pandemic.

Implications for planning:

While there is a role for the less disruptive social distance measures such as voluntary home isolation in any pandemic, school closures and the cancelling of public events are generally only justified in very severe pandemics because of their severe social impact over an extended period of time until a pandemic specific vaccine becomes available.

4. Potential subsequent waves

What we know:

- a) Pandemic influenza can cause more than one epidemic, known as a wave, within a country. Appendix 2 includes illustrations of previous epidemics.
- b) Some supplies of vaccine specific to the pandemic virus may be available before a second or third wave of a pandemic - if they arise. In the 2009 pandemic vaccine only became generally available sometime after the peak of the second wave in the UK. Without the suppression effect in the holiday period (see section 3.6d) the vaccine would have arrived after the vast majority of the epidemic was over.
- c) Of the three pandemics of the 20th Century, only that of 1918-19 generally produced national epidemics with second waves and thus in only one of these pandemics would a pandemic specific vaccine be of general value in controlling the pandemic.
- d) It is expected that vaccine specific to the pandemic virus will start to become available approximately 4-6 months after the start of the pandemic (WHO website 2007, DHSC 2005b). Even if there is time to produce some vaccine before the start of the second wave, there may not be time to produce a large amount, which may take 8-12 months.
- e) The main impact of vaccination with a pandemic-specific vaccine, if it were available, is therefore entirely dependent on the timing and size of any second and subsequent waves in relation to the first wave (and vaccine manufacturing and delivery schedules) and hence inherently difficult to estimate.
- f) The priority groups for vaccination will depend on the previous history of the pandemic. Between waves it may be preferable to vaccinate those groups with the greatest transmission to prevent a further wave.
- g) Some limited impact will occur if a substantial quantity of vaccine becomes available within, rather than before, a second wave (or extended first wave). The rapid final delivery to those to be immunised would be essential to obtain a significant effect. In this case the vaccine should be targeted at those most at risk of serious illness.
- h) Surveys of immunity patterns through and following the first and subsequent waves are essential to planning a pandemic specific vaccination strategy (Vynnycky et al. 2006).

- i) The number of individuals who develop immunity to the pandemic strain in response to the first wave and subsequent waves will depend on the overall attack rate, which in turn will depend on the intervention strategies adopted (e.g. containment strategies involving pure prophylaxis would, if successful, leave relatively few people immune). The proportion of the population who are immune to the pandemic strain at the start of a second wave could therefore vary widely, depending on the intervention strategies adopted during the first wave.
- j) If strategies controlling the epidemic are successful (i.e. complete coverage with pre-pandemic vaccine coupled with household prophylaxis) widespread vaccination with the pandemic specific vaccine will be necessary to provide sufficient population immunity to allow suspension of antiviral interventions.

Implications for planning:

- I. Set up arrangements for the required robust surveys of the background level of immunity across the population that was present before the first (and possibly only) wave.
- II. Set up arrangements for robust surveys of the level of immunity across the population during and after the first (and possibly only) wave.
- III. Ensure arrangements exist for the rapid immunisation of the population as vaccine becomes available and that these can cope with different prioritisation strategies.

Annex 1: Indicative impacts of countermeasures

This annex provides a graphical illustration of the indicative impacts of different countermeasures, both individually and in combination. The analysis follows from the discussion in the main text of this report, and is presented for three different clinical attack rates: 50%, 35% and 25%.

The four countermeasures considered are:

Countermeasure	Effect on disease	When it is most effective
Antivirals (AV)	Reduces severity of disease and can reduce the overall attack rate.	Depending on stockpile size and size of the pandemic, antivirals may be used for just 'at risk' or to treat all those infected. Best used within 48 hours of symptom onset, and ideally within 24 hours for maximum effect (the tables assume the latter). Needs to be given to the majority of infected people to have sizeable impact.
Antibiotics (AB)	Treats bacterial complications, reducing hospitalisation and deaths.	Antibiotics would be used to treat those with complications. Only effective if complications are bacterial and not viral.
Pre-pandemic vaccine (PPV)	Reduces number of cases, hospitalisations and deaths	Pre-pandemic vaccine use may be targeted at 'at risk' or used for everyone. The efficacy for PPV may be low if it provides a poor match to the prevailing strain.
Household prophylaxis with antivirals	Mitigate and slow the progress of the disease more than antiviral treatment	For any stockpile where household prophylaxis is possible (i.e. more than 50% coverage), beginning with prophylaxis and, if necessary, later reverting to reactive treatment is likely to minimise the number of deaths. The household prophylaxis scenarios also assume a policy of reactive school closure.

The following options of combinations of countermeasures are considered:

Option	Description	Percentage of population covered by stockpile			
		Antivirals (Reactive)	Antiviral prophylaxis	Antibiotics	Pre-Pandemic Vaccine
0	No intervention	0%	0%	0%	0%
1	Reactive treatment with antivirals, no vaccine or antibiotics	25%	0%	0%	0%
2	Reactive treatment with antivirals, no vaccine or antibiotics	50%	0%	0%	0%
3	Reactive treatment with antivirals and antibiotics, no vaccine	50%	0%	25%	0%
4	Reactive treatment with antivirals and antibiotics. Targeted vaccine.	50%	0%	25%	45%
5	Reactive treatment with antivirals and antibiotics. All vaccinated	50%	0%	25%	100%
6	Antiviral household prophylaxis, reactive antibiotics & no vaccine	80%		25%	0%
7	Antiviral household prophylaxis, reactive antibiotics & targeted vaccine	80%		25%	45%
8	Antiviral household prophylaxis, reactive antibiotics & all vaccinated	80%		25%	100%

Note: Reactive school closure is also assumed in the household prophylaxis scenarios

The incremental nature of these options can also be illustrated in diagrammatic form:

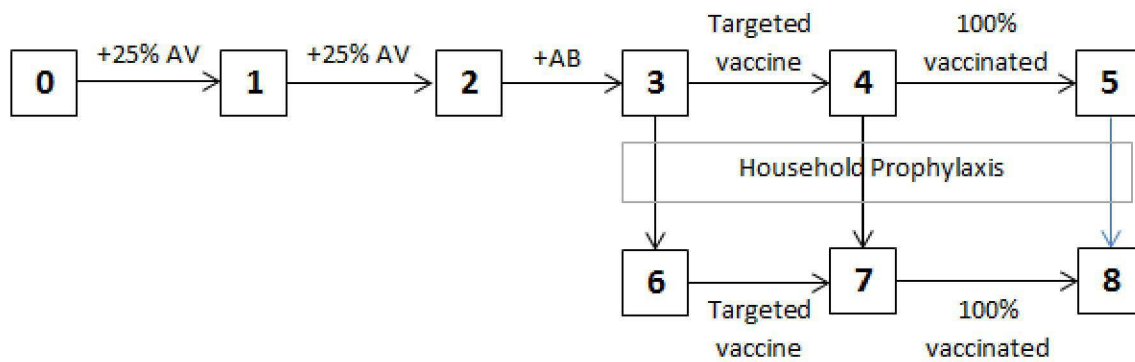

The effects of each option are measured by the expected numbers of clinical cases, hospitalisations and deaths.

Specific assumptions are taken from the main text of this report, and typically reflect the most likely outcome for any level of intervention, together with a margin for uncertainty. This is shown in the following diagrams. The coloured bar indicates high and low estimates using different hospitalisation and case fatality rates. A population of 60 million is assumed.

Illustrative effects of countermeasures - A. Raw clinical attack rate of 50%

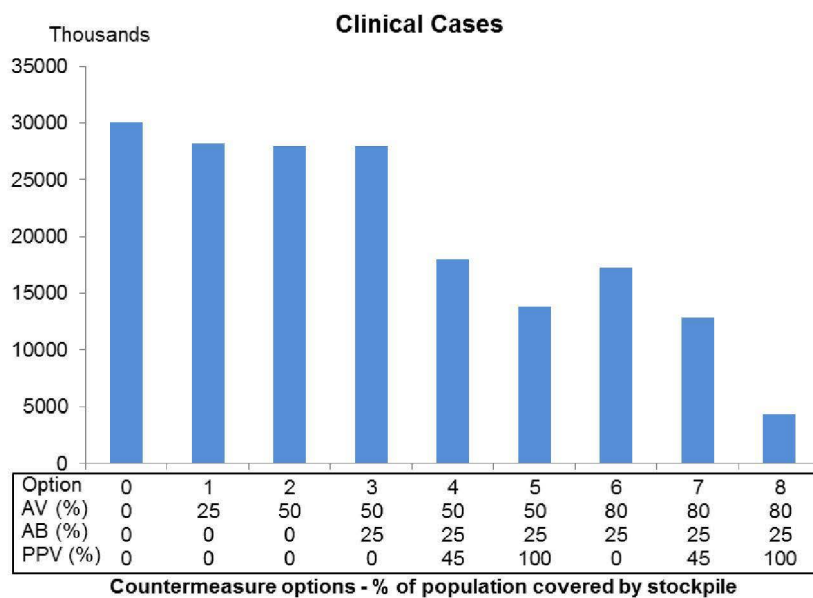

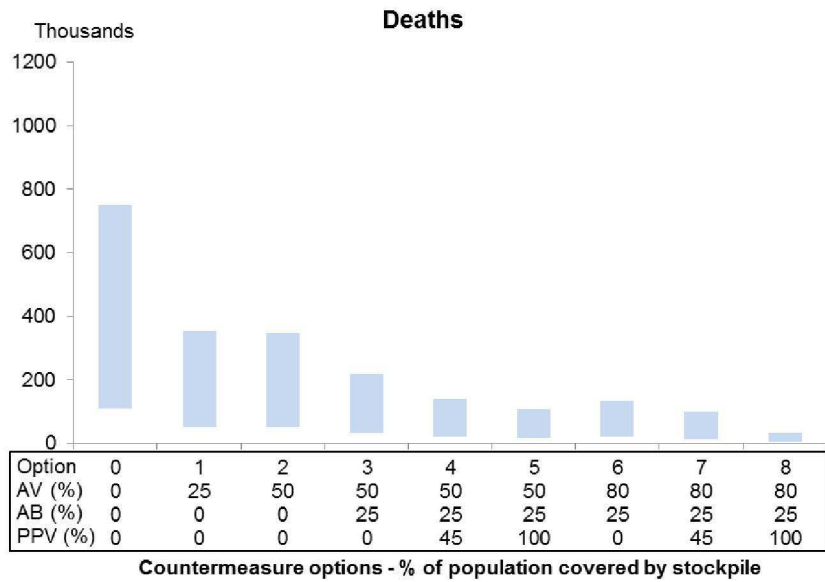
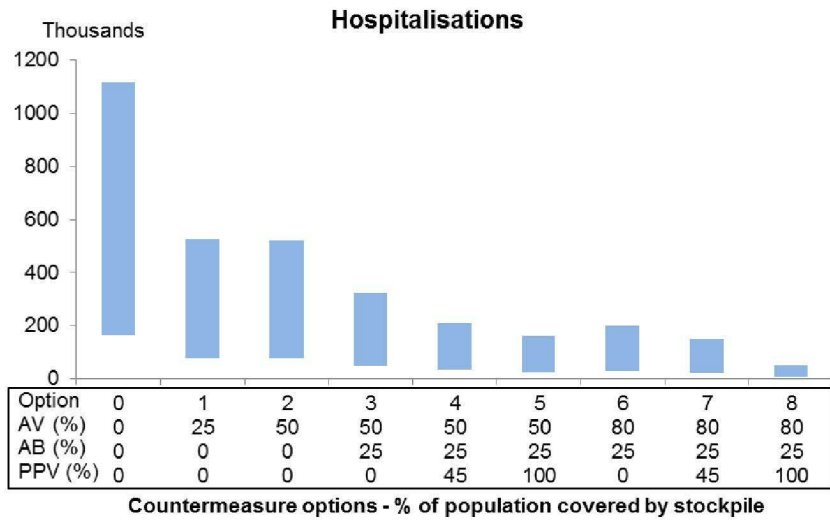

B. Raw clinical attack rate of 35%

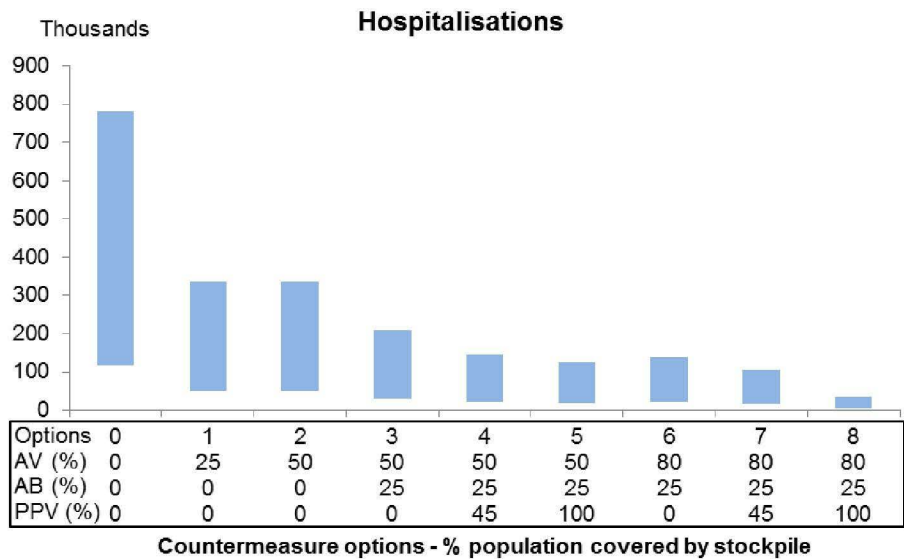
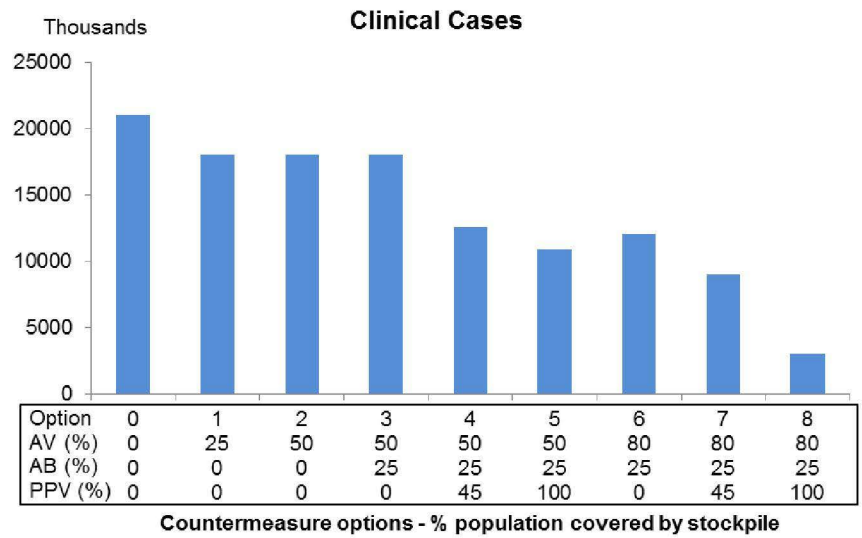

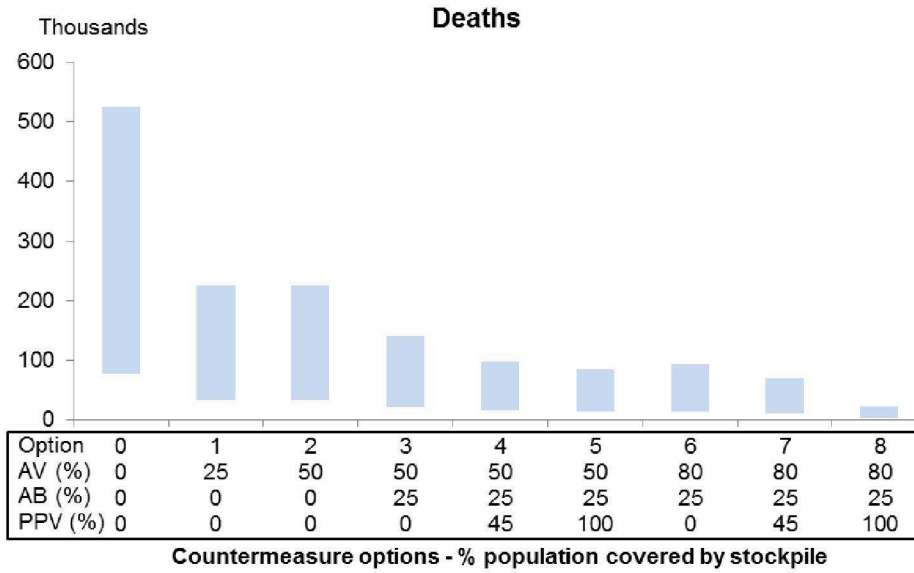

C. Raw clinical attack rate of 25%

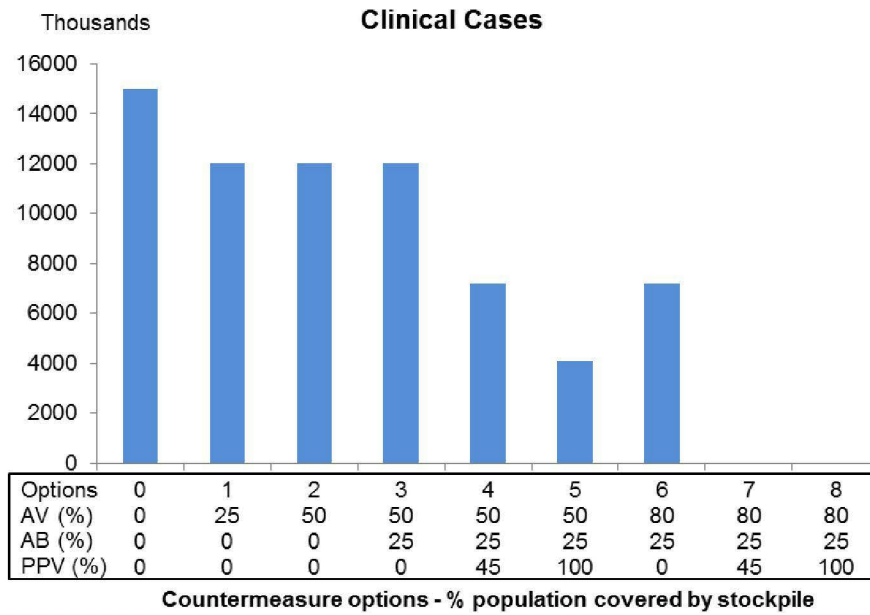

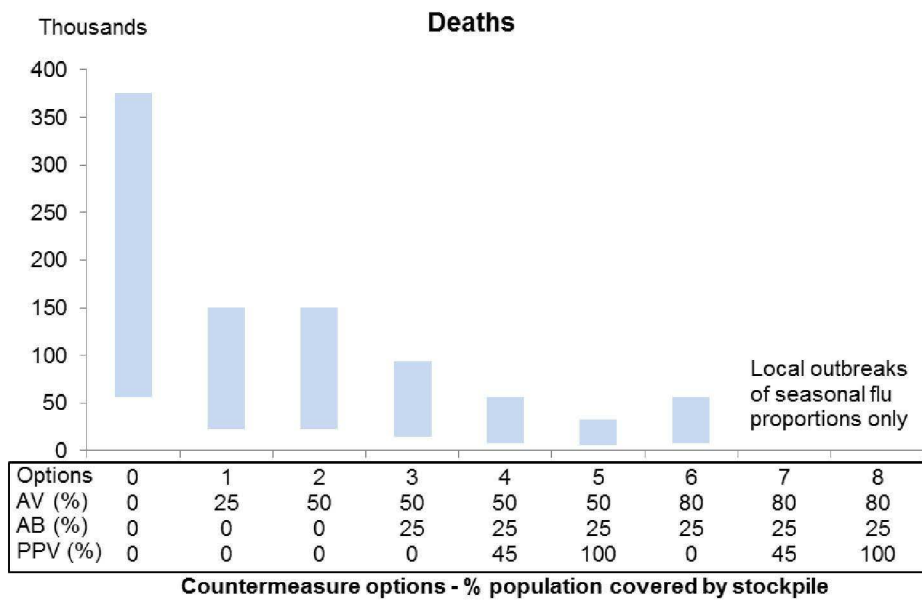
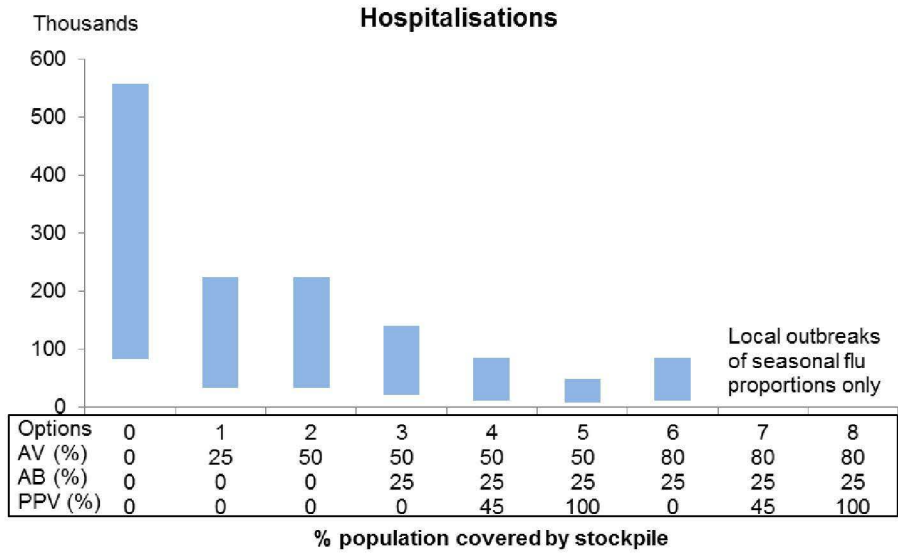

Annex 2: Advised National Planning Scenario for the Reasonable Worst Case

The “reasonable worst case” (RWC) is a concept developed for emergency planning in the UK. This concept is designed to exclude theoretically possible scenarios, which have so little probability of occurring that planning for them would lead to a disproportionate use of resources. They are not predictions of what will happen but of the worst that might realistically happen, and therefore we would expect most pandemics to be less severe and less widespread than the reasonable worst case. By planning for the reasonable worst case, planners are assured that they have a high probability of meeting the demands posed by the hazard should it occur. The RWC is precautionary, as it is not based on the mostly likely scenario, but on a worse scenario that could occur.

- Up to 50% of the population ill (with infection attack rates up to 80-85%) (DHSC 2006c).
- Of which, from 10% up to 25% are expected to have complications, half of these bacteriological (with possibly as little as a 35% overlap between the ‘at risk groups’ and those who actually get complications (Meier et al. 2000)).
- Peak illness rates of around 10 to 12% (measured in new clinical cases per week as a proportion of the population) in each of the weeks in the peak fortnight (DHSC 2005a).
- Absences rates for illness reach 15 to 20% in the peak weeks (at a 50% overall clinical attack rate, assuming an average 7 working day absence for those without complications, 10 for those with, and some allowance for those at home caring for children (DHSC 2006b)).
- Case hospitalisation demand rates up to 4% with an average six day length of stay but, of which 25% could, if the capacity existed, require intensive care for 10 days (i.e. require level 3 critical care).
- Case fatality ratios up to 2.5%.

An indicative planning profile of weekly national numbers of cases, hospitalisations, deaths etc. as proportion of total over single wave pandemic - Department of Health (2005).

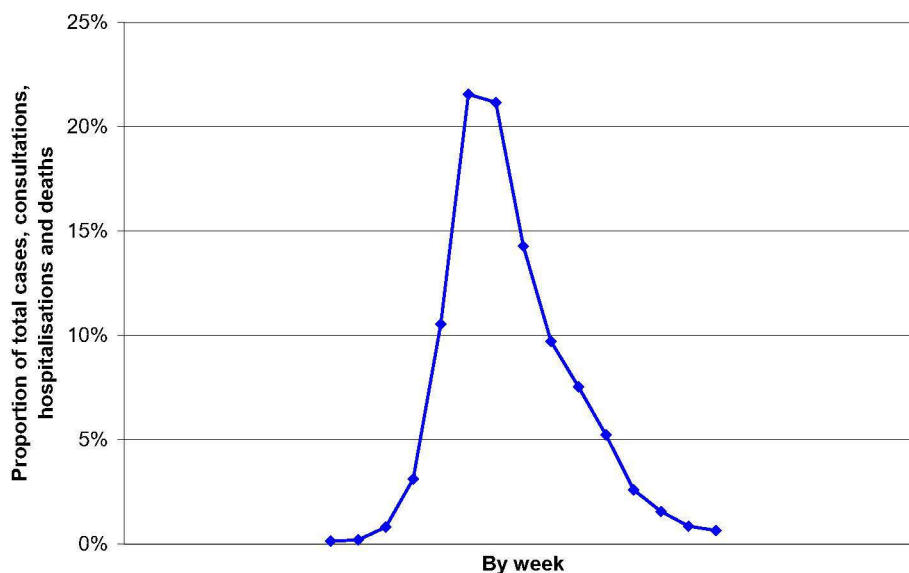

IMPORTANT NOTE: The above chart is NOT a forecast. Its purpose is to provide a reasonable worst case for planning purposes. Below are examples of historical profiles from previous pandemics.

Historical Profiles from Previous Pandemics:

(Dates have been suppressed to emphasise the overall profile)

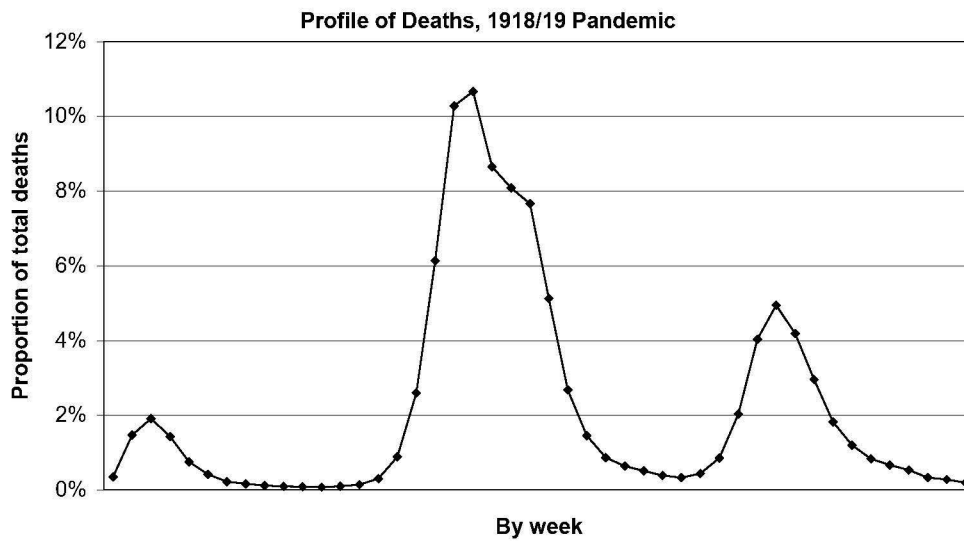

Profile of Q-FLU GP ILI Consultations and NPFS Authorisations, 2009 Pandemic

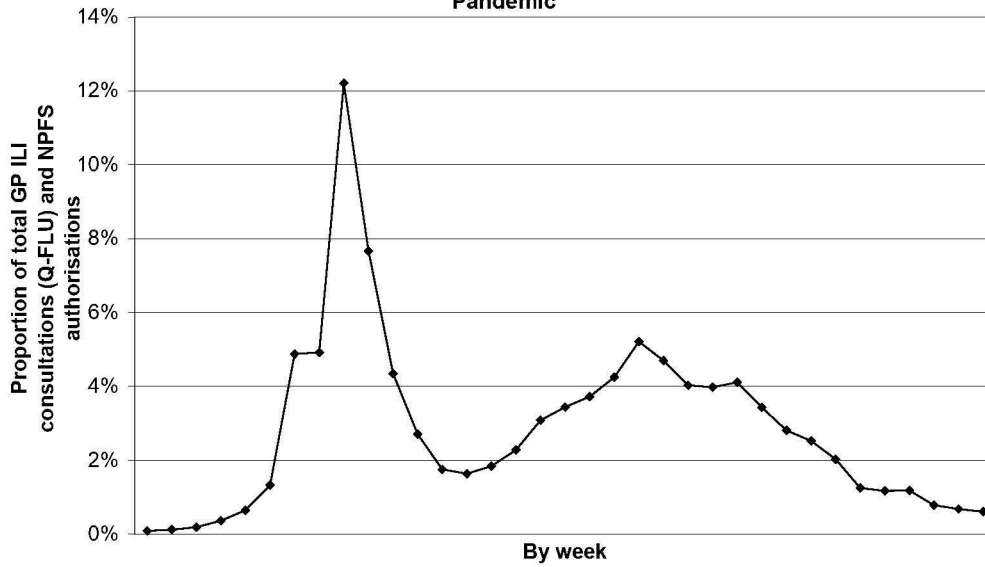

Profile of RCGP, GP ILI Consultations, 1968/69 Pandemic

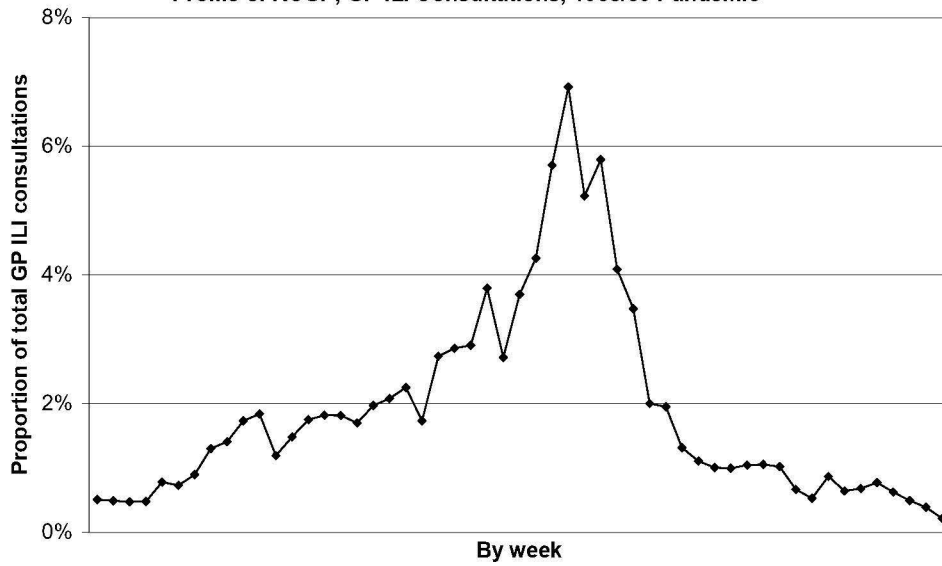

Profile of Deaths, 2009 Pandemic

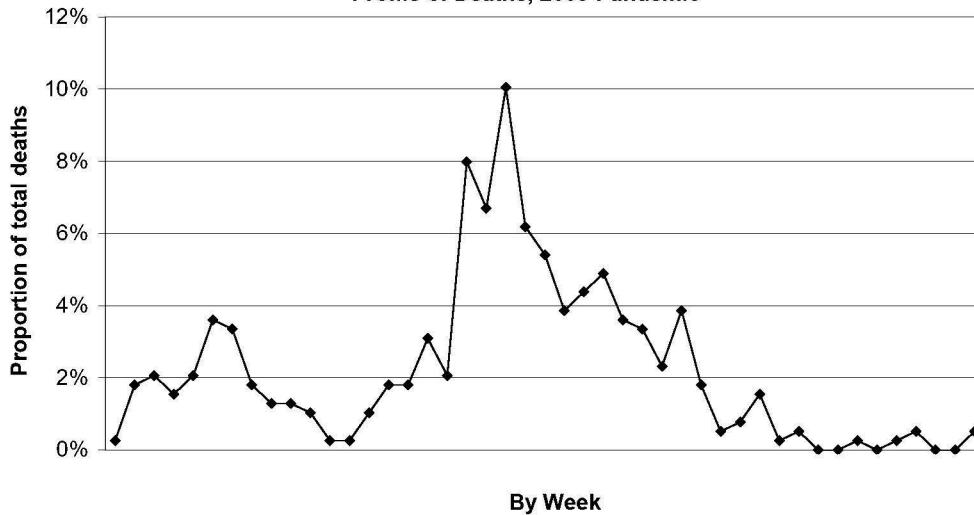

Annex 3: Additional advice on Local Planning Assumptions for Clinical Commissioning Group (CCG) sized areas

- Up to 50% overall clinical attack rate in a 'reasonable worst case'.
- Peak demand in a 'reasonable worst case' of about 13% of population becoming ill in each of peak weeks.
- Local epidemics in some CCG sized areas could be, both up to 50% more highly peaked than the national epidemic, and of a shorter duration, perhaps by a third.
- There may be a large variation in epidemic profile from CCG to CCG. A large proportion of CCG sized areas may have less peaked epidemics than suggested by the national planning profile and similarly a large proportion may have more highly peaked epidemics.
- Planning should take account of the possibility of both short 'highly peaked' local epidemics and also local epidemics more protracted than suggested by the planning profile.

Various examples of possible local profiles both more and less highly peaked than the (national) planning profile are shown below:

Local Planning Profiles: Weekly number of cases, consultations, hospitalisations and deaths etc. as proportion of total over single wave pandemic

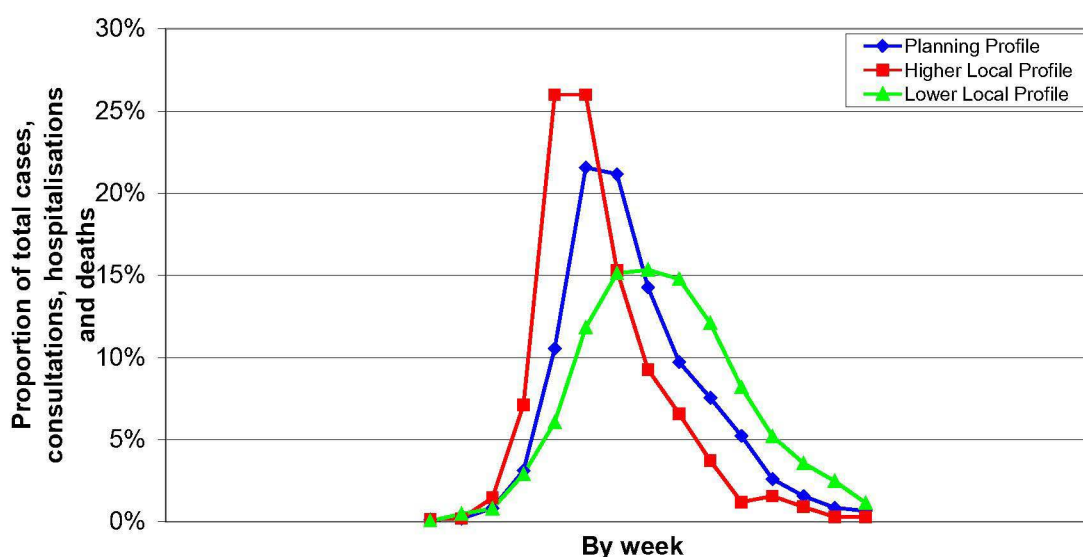

Annex 4: Data Required for Real Time Modelling in an Influenza Pandemic

In a pandemic, real time modelling is possible. This document highlights the information that will be required. It outlines the surveillance information that is required to make predictions of the future course of the UK epidemic and also that required to provide 'nowcasts' of the state of the UK epidemic at any time. It does not specify data types or formats, so for example age information may be supplied as age or date of birth. These matters will be agreed in data specification documents for each data source.

It should be noted that if comparable forecasts are to be made available for the different Devolved Administrations separately, comparable data will also be required. Comparing data across the UK will also be challenging if the interventions across the four countries differ.

Data for real time modelling in a pandemic will come from two sources, aggregate data during the majority of the UK epidemic and individual data mainly from the first few hundred cases placed on an individual case database, the 'FF100' database. The data is split between basic data required to analyse and forecast numbers of cases and deaths, and an extended data set, which would also allow forecasts of the demand for secondary care and absence in both the NHS and elsewhere, as well as a more detailed analysis of development of the UK epidemic.

1. Aggregate level data

Basic Data

- NPFS (from switch-on in a given area) positive identifications of pandemic influenza
 - By age group, sex and risk group (AS&RG), linked with data on broad geographical area (region) (GA);
 - By district and postcode where possible (noting that sample sizes may limit the scope for highly disaggregated analysis);
 - Numbers identified with complications and referred to GPs (by AS&RG)
 - Children referred to GPs for assessment;
 - Delay from symptom onset to treatment;
 - Virological confirmation (of sample).

- GP consultations for ILI, pneumonia and respiratory infections (generally), as well as other conditions that may be associated with the pandemic strain (e.g. encephalitis or diarrhoea, as identified by the analysis of individual level data). These will include both cases sent by the NPFS (if operational) and any additional cases.
 - By age group, sex and risk group, broad geographical area (region);
 - By district and postcode where possible;
 - Rates and numbers;
 - Virological confirmation (of sample).

- Deaths (all cause and ILI related)
 - By age group, sex and risk group;
 - By broad geographical area (region);
 - By date of death and symptom onset.

- Antivirals
 - Courses collected:
 - For treatment;
 - For prophylaxis (if any);
 - By age group, sex, risk group and broad geographical area (region), with further geographical disaggregation if possible.

- Vaccines given
 - By age, sex, risk group and broad geographical area (region), with further geographical disaggregation if possible;
 - Completed courses;
 - Through time, i.e. how many completed courses have been given to whom, by when;
 - Ideally, some assessment of reliability of data feeds from employers, to inform interpretation.

- Epidemiological and clinical studies
 - Immediate, high priority serological study by age and risk group, to assess pre-existing immunity to pandemic virus (requires prioritisation of assay development);
 - Rapid serological survey following first wave of epidemic, by age and risk group, to assess:
 - Immunity (vaccine and natural)
 - Vaccine efficacy
 - Vaccine safety

Extended Data

- Surveys (telephone and/or web based) to include measures of respiratory illness, fever, GP consultations, use of Flu-Service, extent and time of absence from work and length of illness (by AS&RG and GA). Given its national and international connections, London may offer good sampling opportunities.

- Hospital Admissions (by AS&RG and GA)

- Hospital beds occupied (by AS&RG and GA)

- ICU Admissions (by AS&RG and GA and level of care category)

- ICU beds occupied (by AS&RG and GA and level of care category)

- Length of stay Hospital and ICU admissions (by AS&RG and GA)

- GP referrals to hospital (by AS&RG and GA) required to assess demand – these data are not currently available but may be in future.

- School closures:
 - no. of schools (by type and region) currently closed on a given day.
- Absence levels (number of workers absent on a given day):
 - For general workplace;
 - For NHS staff and other essential services;
 - Data on absence for both these categories are not currently available, but may be in future.
- Lab reports (by AS&RG and GA) (including systematic surveys of the population):
 - Of virus isolations or antibody to pandemic strain;
 - Antiviral resistance monitoring.
- Epidemiological and clinical studies
 - Ongoing serological survey (by AS&RG and GA), to assess:
 - Immunity (vaccine and natural);
 - Vaccine efficacy;
 - Vaccine safety.

2. Basic individual-level data from FF100 case investigations and outbreak analysis.

Initial cases will be investigated epidemiologically, and their contacts traced. It is expected, however, that such data will stop being collected as the demands on services increase. As the status of patients change, (e.g. they become virologically confirmed, recover or die, etc.) then the relevant data items need to be updated, and the dates of the update needs to be recorded (even if the patient's status does not change).

This investigation will include, as is most appropriate for each case/contact, testing for virus and antibodies.

Particularly in the case of the FF100 dataset, establishing a reliable and complete dataset of a few individuals and their contacts including virological (and if necessary serological testing) is more important than an incomplete data on a larger number of cases.

The essential requirements of the resulting dataset are:

Cases:

- Unique individual identifiers (to prevent duplication)
- Age, sex, location
- Date of onset
- Suspected or confirmed case (updated as information becomes available. At least weekly).
- Whether antivirals were given, and if so:
 - When were they first given in relation to onset
- Whether vaccine was given
- Date of death or resolution
- Date of hospitalisation
 - Date of admission to critical care high dependency unit
- Date of discharge from hospital
 - Date of discharge from critical care
- Other clinical features of disease

Contacts:

- Unique individual identifiers (to prevent duplication)
- Age, sex, location
- Date or dates of contact with known cases
- Whether they have previously been infected
- If they received prophylaxis
- Their status (with regular updating of):
 - If they become infected (from viral testing or antibody testing 3 weeks after initial exposure);
 - If they become a clinical case.

If they become a case, then the required data for cases should then be collected (maintaining the data on previous prophylaxis if any).

Annex 5: Glossary

R₀: Basic Reproductive Number, (also known as the basic reproduction number or basic reproduction rate): This is the average number of secondary infections produced by a single infected individual while they are infectious, in an entirely susceptible population. This is a measure of the degree of transmissibility of an infection.

Case Fatality Ratio (CFR): (also known as the case fatality rate). The proportion of those who have been clinically attacked, who die because of influenza.

Clinical Attack Rate (CAR): (also known as the clinical attack ratio). The proportion of the considered population infected and showing symptoms over a specified period of time. Some may not develop symptoms severe enough to be readily identified as influenza. The measured clinical attack rate is thus not always the number who actually develop symptoms, but the number remembering symptoms retrospectively, or the number seeking healthcare.

Clinical Case: Someone infected and showing symptoms severe enough to be readily identified as influenza.

Infection Attack Rate: (also known as serological attack rate). The proportion of the considered population infected over a specified period of time, many of whom may not show clinical symptoms.

Influenza Like Illness (ILI): The specific definition for influenza like illness may vary by data source. However, in the UK it is often defined as a temperature of 38°C or greater, plus two or more of the following: unusual tiredness, headache, runny nose, sore throat, shortness of breath or cough, loss of appetite, aching muscles, diarrhoea or vomiting.

Reproductive Number: (Also known as the reproduction number). This is the average number of secondary infections produced by a single infected individual while they are infectious, given the population's characteristics (e.g. immunity). This is a measure of the degree of transmissibility of an infection in the given population.

Reasonable Worst Case (RWC): A concept developed for emergency planning in the UK. This concept is designed to exclude theoretically possible scenarios which have so little probability of occurring that planning for them would lead to a disproportionate use of resources. The RWC is not a prediction of what will happen but of the worst that might realistically happen, and therefore we would expect most pandemics to be less severe and less widespread than the RWC. By planning for the RWC, planners are assured that they have a high probability of meeting the demands posed by the hazard should it occur.

Annex 6: References

- Baguelin, M. et al. (2010). Vaccination against pandemic influenza A/H1N1v in England: A real-time economic evaluation. *Vaccine* 28, 2370–2384.
- Baguelin, M. et al. (2013). Assessing Optimal Target Populations for Influenza Vaccination Programmes: An Evidence Synthesis and Modelling Study. *PLoS Medicine* 10, e1001527.
- Birrell, P.J. et al. (2011). Bayesian modeling to unmask and predict influenza A/H1N1pdm dynamics in London. *Proceedings of the National Academy of Sciences* 108, 18238–18243.
- Brooks-Pollock, E. et al. (2011). Using an online survey of healthcare-seeking behaviour to estimate the magnitude and severity of the 2009 H1N1v influenza epidemic in England. *BMC Infectious Diseases* 11, 68.
- Carrat, F. et al. (2008). Time Lines of Infection and Disease in Human Influenza: A Review of Volunteer Challenge Studies. *American Journal of Epidemiology* 167, 775–785.
- Cauchemez, S. et al. (2008). Estimating the impact of school closure on influenza transmission from Sentinel data. *Nature* 452, 750–754.
- Cauchemez, S. et al. (2009). Closure of schools during an influenza pandemic. *The Lancet Infectious Diseases* 9, 473–481.
- Ciofi degli Atti, M.L. et al. (2008). Mitigation Measures for Pandemic Influenza in Italy: An Individual Based Model Considering Different Scenarios. *PLoS ONE* 3, e1790.
- Colizza, V. et al. (2007). Modeling the Worldwide Spread of Pandemic Influenza: Baseline Case and Containment Interventions. *PLoS Medicine* 4, e13.
- Cooper, B.S. et al. (2006). Delaying the International Spread of Pandemic Influenza. *PLoS Medicine* 3, e212.
- Department of Health & Social Care (DHSC) (2005a)*. Derivation of an “as fast as is reasonable” temporal profile for pandemic flu.
- Department of Health & Social Care (DHSC) (2005b). United Kingdom National Influenza Pandemic Committee (UKNIPC). <http://webarchive.nationalarchives.gov.uk/20090503123233/http://www.advisorybodies.doh.gov.uk/uknipc/minutes/minutes180705.htm>.
- Department of Health & Social Care (DHSC) (2006a)*. Pandemic flu preparedness options: estimating costs and benefits.
- Department of Health & Social Care (DHSC) (2006b)*. Absence from work in an Influenza Pandemic.
- Department of Health & Social Care (DHSC) (2006c)*. The clinical attack rate planning assumption for an Influenza Pandemic: Why 50%?
- Department of Health & Social Care (DHSC) (2011). Responding to a UK flu pandemic. <https://www.gov.uk/government/publications/responding-to-a-uk-flu-pandemic>.
- Dorigatti, I. et al. (2013). Increased transmissibility explains the third wave of infection by the 2009 H1N1 pandemic virus in England. *Proceedings of the National Academy of Sciences* 110, 13422–13427.
- Eames, K.T.D. et al. (2012). Measured Dynamic Social Contact Patterns Explain the Spread of H1N1v Influenza. *PLoS Computational Biology* 8, e1002425.

- European Centre for Disease Prevention and Control (ECDC) (2017). Expert opinion on neuraminidase inhibitors for the prevention and treatment of influenza - review of recent systematic reviews and meta-analyses. <http://ecdc.europa.eu/en/publications-data/expert-opinion-neuraminidase-inhibitors-prevention-and-treatment-influenza-review>.
- Ferguson, N.M. et al. (2006). Strategies for mitigating an influenza pandemic. *Nature* 442, 448–452.
- Ferguson, N.M. (2007)*. Key worker prophylaxis: Report for Department of Health.
- Finnie, T.J.R. et al. (2011)*. Extent and severity of the 1889-1893 influenza pandemic in Great Britain. Public Health England (PHE).
- Fraser, C. et al. (2009). Pandemic Potential of a Strain of Influenza A (H1N1): Early Findings. *Science* 324, 1557–1561.
- Gani, R. et al. (2005). Potential Impact of Antiviral Drug Use during Influenza Pandemic. *Emerging Infectious Diseases* 11, 1355–1362.
- Health Protection Agency (HPA) (2005)*. The potential impact of movement restrictions on the spread of pandemic influenza in England, Wales and Scotland as gauged by the application of a meta-population patch model. Centre for Emergency Preparedness & Response, Porton Down, UK.
- Health Protection Agency (HPA) (2010). Epidemiological report of pandemic (H1N1) 2009 in the UK; April 2009 – May 2010. http://webarchive.nationalarchives.gov.uk/201407141113122/http://www.hpa.org.uk/webc/HPAwebFile/HPAweb_C/1284475321350.
- Inglesby, T.V. et al. (2006). Disease Mitigation Measures in the Control of Pandemic Influenza. *Biosecurity and Bioterrorism: Biodefense Strategy, Practice, and Science* 4, 366–375.
- Longini, I.M. (2004). Containing Pandemic Influenza with Antiviral Agents. *American Journal of Epidemiology* 159, 623–633.
- Mann, P.G. et al. (1981). A Five-Year Study of Influenza in Families Joint Public Health Laboratory Service/Royal College of General Practitioners Working Group. *Journal of Hygiene* 87, 191–200.
- Marziano, V. et al. (2017). Detecting a Surprisingly Low Transmission Distance in the Early Phase of the 2009 Influenza Pandemic. *Scientific Reports* 7.
- Mateus, A.L.P. et al. (2014). Effectiveness of travel restrictions in the rapid containment of human influenza: a systematic review. *Bull World Health Organ* 92, 868–880D.
- Meier, C.R. et al. (2000). Population-Based Study on Incidence, Risk Factors, Clinical Complications and Drug Utilisation Associated with Influenza in the United Kingdom. *European Journal of Clinical Microbiology & Infectious Diseases* 19, 834–842.
- Merler, S., and Ajelli, M. (2010). The role of population heterogeneity and human mobility in the spread of pandemic influenza. *Proceedings of the Royal Society B: Biological Sciences* 277, 557–565.
- Merler, S. et al. (2011). Determinants of the Spatiotemporal Dynamics of the 2009 H1N1 Pandemic in Europe: Implications for Real-Time Modelling. *PLOS Computational Biology* 7, e1002205.
- Miller, E. et al. (2010). Incidence of 2009 pandemic influenza A H1N1 infection in England: a cross-sectional serological study. *Lancet* 375, 1100–1108.
- Monto, A.S. (1987). Influenza: Quantifying morbidity and mortality. *The American Journal of Medicine* 82, 20–25.

- Nguyen-Van-Tam, J.S. (2003). The epidemiology and clinical impact of pandemic influenza. *Vaccine* 21, 1762–1768.
- Nguyen-Van-Tam, J.S. et al. (2004). Response - Tackling the next influenza pandemic: Ring prophylaxis may prove useful early on, but is unlikely to be effective or practical to implement once the pandemic is established. *BMJ* 328, 1391–1392.
- Office for National Statistics (ONS) (2016). Travel trends estimates: overseas residents in the UK.
<https://www.ons.gov.uk/peoplepopulationandcommunity/leisureandtourism/datasets/overseasresidentsvisitsstotheuk>.
- Parsons, H.F. (1891). Report on the Influenza Epidemic of 1889–90 H.M.S.O.
- Parsons, H.F. (1893). Further Report and Papers on Epidemic Influenza, 1889-92 H.M.S.O.
- Pebody, R.G. et al. (2011). Use of Antiviral Drugs to Reduce Household Transmission of Pandemic (H1N1) 2009, United Kingdom. *Emerging Infectious Diseases* 17, 990–999.
- Pitman, R.J. et al. (2005). Entry screening for severe acute respiratory syndrome (SARS) or influenza: policy evaluation. *BMJ* 331, 1242.2-1243.
- Presanis, A.M. et al. (2011). Changes in severity of 2009 pandemic A/H1N1 influenza in England: a Bayesian evidence synthesis. *BMJ* 343, d5408–d5408.
- Sadique, Z. et al. (2008). Estimating the costs of school closure for mitigating an influenza pandemic. *BMC Public Health* 8.
- SQW Consulting (2007)*. Report for the Cabinet Office: Study into the impact of school closure on the critical national infrastructure.
- Valleron, A.-J. et al. (2010). Transmissibility and geographic spread of the 1889 influenza pandemic. *Proceedings of the National Academy of Sciences* 107, 8778–8781.
- Venkatesan, S. et al. (2017). Impact of Outpatient Neuraminidase Inhibitor Treatment in Patients Infected With Influenza A(H1N1)pdm09 at High Risk of Hospitalization: An Individual Participant Data Metaanalysis. *Clinical Infectious Diseases* 64, 1328–1334.
- Vynnycky, E. (2005)*. The effect of vaccination and provision of antivirals on the transmission dynamics of influenza. Health Protection Agency Centre for Infections, Colindale, London, UK.
- Vynnycky, E. (2006)*. Estimating the effect of vaccination against pandemic influenza. Health Protection Agency Centre for Infections, Colindale, London, UK.
- World Health Organisation (WHO) (2007). Questions and Answers on Pandemic Influenza Vaccine. Immunization, Vaccines and Biologicals.
http://www.who.int/immunization/newsroom/PI_QAs/en/.
- World Health Organisation (WHO) Avian and other zoonotic influenza. Influenza.
http://www.who.int/csr/disease/avian_influenza/.

Note: References marked with an asterisk are not currently publicly available, being pre-publication drafts or internal DHSC or Cabinet Office reference papers.